

1

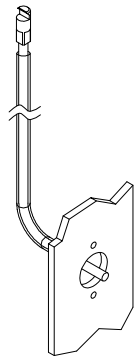

2

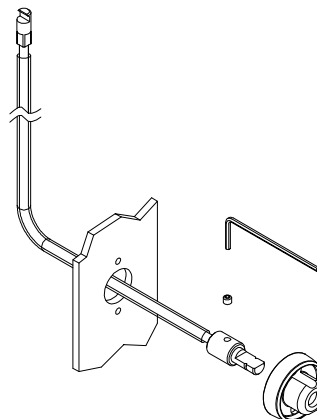

3

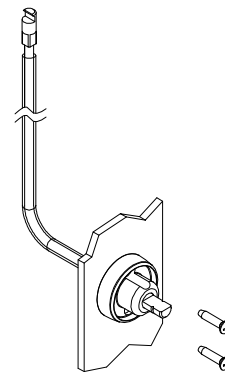

4

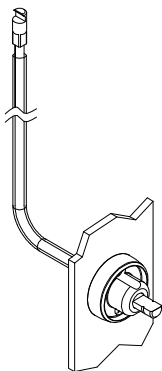

5

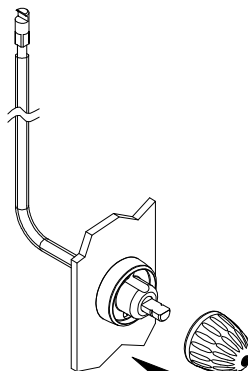

6

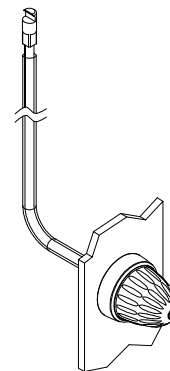

7

N° REVISIONE	DESCRIZIONE	DATA
	 DESCRIZIONE: MONTAGGIO POMOLO STANDARD	DISEGNO: SL20P IM AL
PROG.: Ing. G. Nicolosi	MATERIALE:	
VERIF.: G.N.	TRATTAMENTO:	TOLL. GEN.:
DATA: 19.04.02	CLIENTE:	SCALA: 1:2

Disegno di proprietà della Pellini S.p.A. Vietato esporlo o riprodurlo senza autorizzazione.